

1

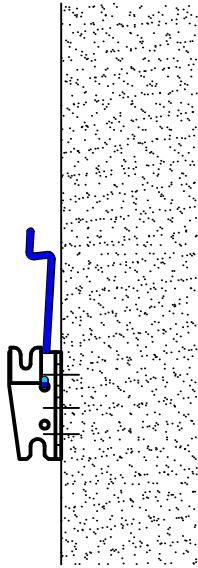

2

3

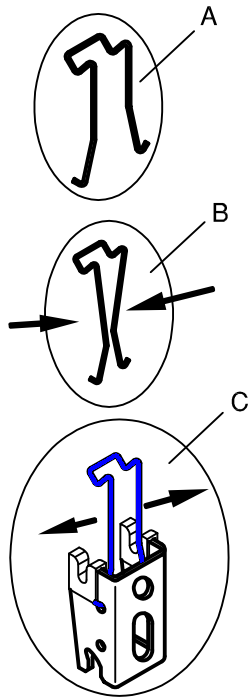

4

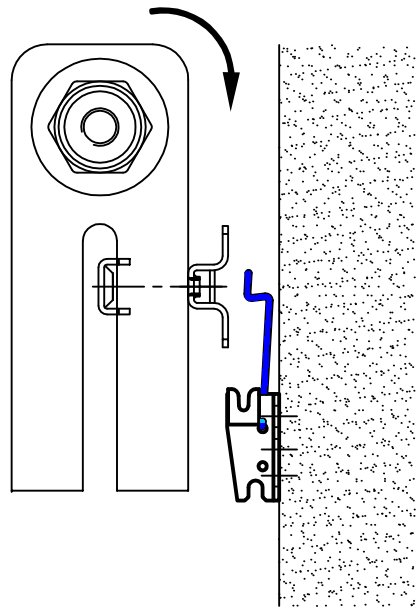

5

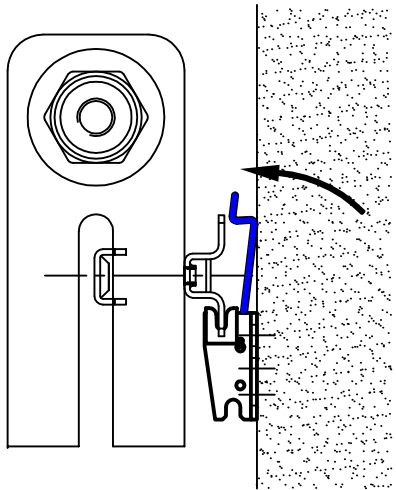

6

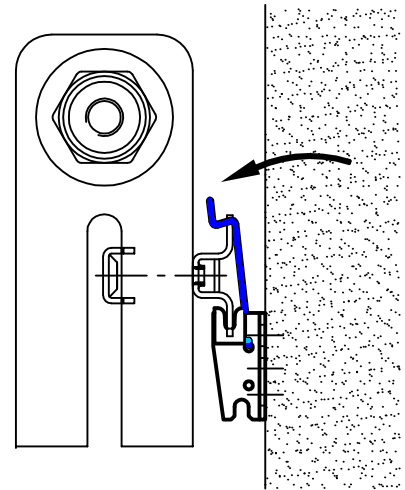

4 x BH	2 x	4 x CVD
6 x BH	2 x	6 x CVD
8 x BH	2 x	8 x CVD

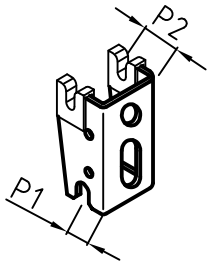
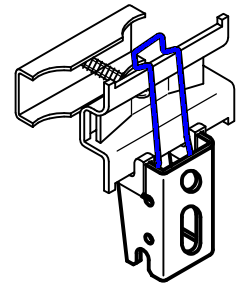
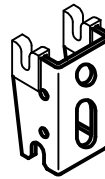
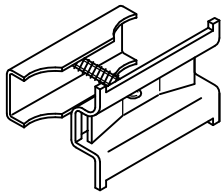

$D2 = WA + T$

CVD0	P1	P2	WA	D				
				T	62	100	136	173
	10	-	23	54	73	91	109	128
	-	15	28	59	78	96	114	133

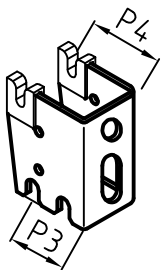
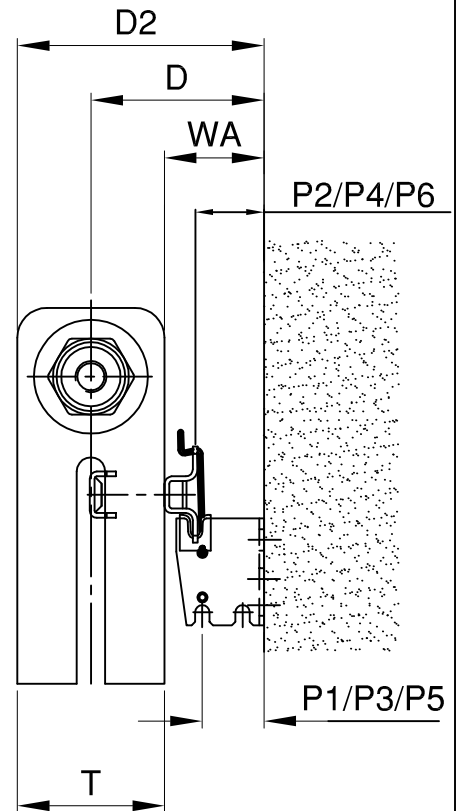

$D2 = WA + T$

CVD1	P3	P4	WA	D				
				T	62	100	136	173
	25	-	38	69	88	106	124	143
	-	30	43	74	93	111	129	148

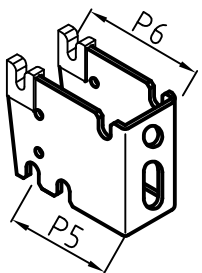

$D2 = WA + T$

CVD2	P5	P6	WA	D				
				T	62	100	136	173
	45	-	58	89	108	126	144	163
	-	50	63	94	113	131	149	168

